

European standard range

600 x 400

12



1 8 litres - Ref. 21008 

polypropylene
Ext. dim.: L 600 X w 400 X h 50 mm
Ext. dim.: L 23.6 X w 15.8 X h 2.0"
Int. dim.: L 555 X w 355 X h 40 mm
Int. dim.: L 21.9 X w 14.0 X h 1.6"
Wt: 0.80 kg/1.7 lbs., Colour: **grey**.
SKU quantity: 130



2 12 litres - Ref. 21013

polypropylene
Ext. dim.: L 600 X w 400 X h 73 mm
Ext. dim.: L 23.6 X w 15.8 X h 2.9"
Int. dim.: L 555 X w 355 X h 62 mm
Int. dim.: L 21.9 X w 14.0 X h 2.4"
Wt: 1.08 kg/2.4 lbs., Colour: **grey, red**.
SKU quantity: 85



3 12 litres - Ref. 21015

polypropylene
solid base, ventilated sides
Ext. dim.: L 600 X w 400 X h 73 mm
Ext. dim.: L 23.6 X w 15.8 X h 2.9"
Int. dim.: L 555 X w 355 X h 62 mm
Int. dim.: L 21.9 X w 14.0 X h 2.4"
Wt: 1.02 kg/2.2 lbs., Colour: **grey**.
SKU quantity: 85



4 12 litres - Ref. 21014 

polypropylene
ventilated sides and base
Ext. dim.: L 600 X w 400 X h 73 mm
Ext. dim.: L 23.6 X w 15.8 X h 2.9"
Int. dim.: L 555 X w 355 X h 62 mm
Int. dim.: L 21.9 X w 14.0 X h 2.4"
Wt: 0.96 kg/2.1 lbs., Colour: **grey**.
SKU quantity: 85



5 20 litres - Ref. 03019

Ext. dim.: L 600 X w 400 X h 120 mm
Ext. dim.: L 23.6 X w 15.8 X h 4.7"
Int. dim.: L 555 X w 358 X h 104 mm
Int. dim.: L 21.9 X w 14.1 X h 4.1"
Wt: 1.27 kg/2.8 lbs., Colour: **white**.
SKU quantity: 50



6 20 litres - Ref. 20019

polypropylene
solid base, ventilated sides
Ext. dim.: L 600 X w 400 X h 120 mm
Ext. dim.: L 23.6 X w 15.8 X h 4.7"
Int. dim.: L 555 X w 358 X h 104 mm
Int. dim.: L 21.9 X w 14.1 X h 4.1"
Wt: 1.17 kg/2.6 lbs., Colour: **grey**.
SKU quantity: 50



7 20 litres - Ref. 20016 

polypropylene
ventilated sides and base
Ext. dim.: L 600 X w 400 X h 120 mm
Ext. dim.: L 23.6 X w 15.8 X h 4.7"
Int. dim.: L 555 X w 358 X h 104 mm
Int. dim.: L 21.9 X w 14.1 X h 4.1"
Wt: 1.10 kg/2.4 lbs., Colour: **grey**.
SKU quantity: 50



8 21 litres - Ref. 2A021 

polypropylene
Ext. dim.: L 600 X w 400 X h 118 mm
Ext. dim.: L 23.6 X w 15.8 X h 4.6"
Int. dim.: L 555 X w 355 X h 105 mm
Int. dim.: L 21.9 X w 14.0 X h 4.1"
Wt: 1.36 kg/3.0 lbs., Colour: **grey, red, blue, white**.
SKU quantity: 50



9 21 litres - Ref. 2AP21

minimum order item
polypropylene
as container ref. 2A021 with open handles



10 21 litres - Ref. 2A023

polypropylene
solid base, ventilated sides
Ext. dim.: L 600 X w 400 X h 118 mm
Ext. dim.: L 23.6 X w 15.8 X h 4.6"
Int. dim.: L 555 X w 355 X h 105 mm
Int. dim.: L 21.9 X w 14.0 X h 4.1"
Wt: 1.28 kg/2.8 lbs., Colour: **grey**.
SKU quantity: 50



11 21 litres - Ref. 2A022 

polypropylene
ventilated sides and base
Ext. dim.: L 600 X w 400 X h 118 mm
Ext. dim.: L 23.6 X w 15.8 X h 4.6"
Int. dim.: L 555 X w 355 X h 105 mm
Int. dim.: L 21.9 X w 14.0 X h 4.1"
Wt: 1.11 kg/2.4 lbs., Colour: **grey**.
SKU quantity: 50

SKU (Stock Keeping Unit): Attractive discounts are available for products ordered in SKU quantities.

 Strategic Product: We aim to always hold stock of strategic products in colours identified in bold.

**12 28 litres - Ref. 20028** 

polypropylene
Ext. dim.: L 600 X w 400 X h 150 mm
Ext. dim.: L 23.6 X w 15.8 X h 5.9"
Int. dim.: L 555 X w 355 X h 139 mm
Int. dim.: L 21.9 X w 14.0 X h 5.5"
Wt: 1.48 kg/3.3 lbs., Colour: **grey**.
SKU quantity: 35

**13 28 litres - Ref. 20030**

polypropylene
solid base, ventilated sides
Ext. dim.: L 600 X w 400 X h 150 mm
Ext. dim.: L 23.6 X w 15.8 X h 5.9"
Int. dim.: L 555 X w 355 X h 139 mm
Int. dim.: L 21.9 X w 14.0 X h 5.5"
Wt: 1.38 kg/3.04 lbs., Colour: **grey**.
SKU quantity: 35

**14 28 litres - Ref. 20029** 

polypropylene
ventilated sides and base
Ext. dim.: L 600 X w 400 X h 150 mm
Ext. dim.: L 23.6 X w 15.8 X h 5.9"
Int. dim.: L 555 X w 355 X h 139 mm
Int. dim.: L 21.9 X w 14.0 X h 5.5"
Wt: 1.25 kg/2.7 lbs., Colour: **grey**.
SKU quantity: 35

**15 32 litres - Ref. 06032**

polypropylene
ventilated sides and base
Ext. dim.: L 600 X w 400 X h 170 mm
Ext. dim.: L 23.6 X w 15.8 X h 6.7"
Int. dim.: L 555 X w 355 X h 158 mm
Int. dim.: L 21.9 X w 14.0 X h 6.2"
Wt: 1.22 kg/2.7 lbs., Colour: **grey**.
SKU quantity: 30

**16 33 litres - Ref. 21033** 

polypropylene
Ext. dim.: L 600 X w 400 X h 175 mm
Ext. dim.: L 23.6 X w 15.8 X h 6.9"
Int. dim.: L 555 X w 355 X h 164 mm
Int. dim.: L 21.9 X w 14.0 X h 6.5"
Wt: 1.70 kg/3.7 lbs., Colour: **grey, red, blue**.
SKU quantity: 30

**17 33 litres - Ref. 21038**

polypropylene
solid base, ventilated on long sides
Ext. dim.: L 600 X w 400 X h 175 mm
Ext. dim.: L 23.6 X w 15.8 X h 6.9"
Int. dim.: L 555 X w 355 X h 164 mm
Int. dim.: L 21.9 X w 14.0 X h 6.5"
Wt: 1.63 kg/3.6 lbs., Colour: **grey**.
SKU quantity: 30

18 Ref. 91005 

dolly for 600 X 400 and 400 X 300 mm
ESR containers (see p. 60)

**19 35 litres - Ref. 21035** 

ventilated sides and base
Ext. dim.: L 600 X w 400 X h 193 mm
Ext. dim.: L 23.6 X w 15.8 X h 7.5"
Int. dim.: L 555 X w 355 X h 167 mm
Int. dim.: L 21.9 X w 14.0 X h 6.7"
Wt: 1.69 kg/3.7 lbs., Colour: **grey, brown-red, orange**.
SKU quantity: 30

20 35 litres - Ref. 04035

minimum order item
solid base, ventilated sides
version of ref. 21035
Wt: 1.87 kg/4.1 lbs., Colour: **white**.

European standard range

600 x 400

14

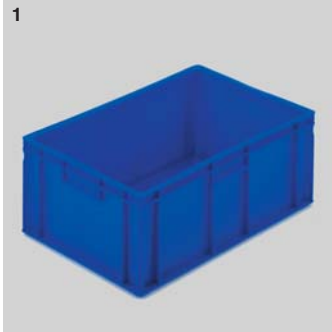

1 45 litres - Ref. 2A045 
polypropylene
incorporates strapping facility for secure palletisation
Ext. dim.: L 600 X w 400 X h 235 mm
Ext. dim.: L 23.6 X w 15.8 X h 9.3"
Int. dim.: L 555 X w 355 X h 220 mm
Int. dim.: L 21.9 X w 14.0 X h 8.7"
Wt: 2.18 kg/4.8 lbs. Colour: **grey, red, blue, white**. SKU quantity: 20



2 45 Litres - Ref. 2B045
polypropylene
as ref. 2A045 without central ribs, creates a much larger area for printing owner's logo, telephone number and advertising message - see page 98
Wt: 2.18 kg/4.8 lbs.
Colour: grey, red, blue.
SKU quantity: 20



3 45 litres - Ref. 2A049 
polypropylene
as ref. 2A045 with cut-out hand holds
Wt: 2.14 Kg/4.7 lbs.
Colour: **grey, blue**.
SKU quantity: 20



4 Ref. 61045 
polypropylene
snap-shut lid for 600 X 400 ESR containers
Ext. dim.: L 613 X w 411 X h 39 mm
Ext. dim.: L 24.2 X w 16.2 X h 1.5"
Wt: 0.87 kg/1.9 lbs.
Colour: **grey, red**.
SKU quantity: 14

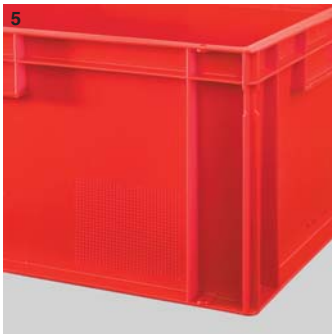

5 45 litre Options
Refs. 2A045, 2B045 and 2A049 can be manufactured with pimple-pads, for easy removal of adhesive labels. All 45 litre Euro containers can be fitted with an integral card clip. Containers with solid bases can also be supplied with four drainage holes.



6 45 litres - Ref. 2A046
polypropylene
solid base, ventilated sides, incorporates strapping facility for secure palletisation.
Ext. dim.: L 600 X w 400 X h 235 mm
Ext. dim.: L 23.6 X w 15.8 X h 9.3"
Int. dim.: L 555 X w 355 X h 220 mm
Int. dim.: L 21.9 X w 14.0 X h 8.7"
Wt: 1.88 kg/4.1 lbs., Colour: red.
SKU quantity: 20



7 45 litres - Ref. 2A044 
polypropylene
ventilated sides and base, incorporates strapping facility for secure palletisation
Ext. dim.: L 600 X w 400 X h 235 mm
Ext. dim.: L 23.6 X w 15.8 X h 9.3"
Int. dim.: L 555 X w 355 X h 215 mm
Int. dim.: L 21.9 X w 14.0 X h 8.5"
Wt: 1.83 kg/4.0 lbs., Colour: **grey**.
SKU quantity: 20



8 52 litres - Ref. 21055
ventilated sides and base
Ext. dim.: L 600 X w 400 X h 280 mm
Ext. dim.: L 23.6 X w 15.8 X h 11.0"
Int. dim.: L 555 X w 355 X h 255 mm
Int. dim.: L 21.9 X w 14.0 X h 10.0"
Wt: 2.18 kg/4.8 lbs., Colour: grey.
SKU quantity: 20



9 54 litres - Ref. 21054 
Ext. dim.: L 600 X w 400 X h 280 mm
Ext. dim.: L 23.6 X w 15.8 X h 11.0"
Int. dim.: L 555 X w 355 X h 265 mm
Int. dim.: L 21.9 X w 14.0 X h 10.4"
Wt: 2.51 kg/5.5 lbs., Colour: **grey**.
SKU quantity: 20



11 60 litres - Ref. 21060 
Ext. dim.: L 600 X w 400 X h 319 mm
Ext. dim.: L 23.6 X w 15.8 X h 12.6"
Int. dim.: L 555 X w 355 X h 300 mm
Int. dim.: L 21.9 X w 14.0 X h 11.8"
Wt: 2.75 kg/6.6 lbs., Colour: **grey, red, white**.
SKU quantity: 35



12 Ref. 61060 
polypropylene
lid for 600 X 400 mm ESR containers
Ext. dim.: L 600 X w 400 X h 30 mm
Ext. dim.: L 23.6 X w 15.8 X h 1.2"
Wt: 0.87 kg/1.9 lbs., Colour: **grey, blue, red, white**.
SKU quantity: 18



13 60 litres - Ref. 21063
as ref. 21060 with closed handles
Wt: 2.88 kg/6.4 lbs., Colour: grey.
SKU quantity: 35

10 Ref. 91005 
dolly for 600 X 400 and 400 X 300 mm ESR containers (see P. 60)

SKU (Stock Keeping Unit): Attractive discounts are available for products ordered in SKU quantities.

 Strategic Product: We aim to always hold stock of strategic products in colours identified in bold.

**14 60 litres - Ref. 21061**

solid base, ventilated sides
 Ext. dim.: L 600 X w 400 X h 319 mm
 Ext. dim.: L 23.6 X w 15.8 X h 12.6"
 Int. dim.: L 555 X w 355 X h 300 mm
 Int. dim.: L 21.9 X w 14.0 X h 11.8"
 Wt: 2.31 kg/5.1 lbs., Colour: grey, red.
 SKU quantity: 35

**15 60 litres - Ref. 21064**

ventilated sides and base
 Ext. dim.: L 600 X w 400 X h 319 mm
 Ext. dim.: L 23.6 X w 15.8 X h 12.6"
 Int. dim.: L 555 X w 355 X h 294 mm
 Int. dim.: L 21.9 X w 14.0 X h 11.6"
 Wt: 2.33 kg/5.1 lbs., Colour: grey,
brown.
 SKU quantity: 35

**16 75 litres - Ref. 20085**

Ext. dim.: L 600 X w 400 X h 412 mm
 Ext. dim.: L 23.6 X w 15.8 X h 16.2"
 Int. dim.: L 555 X w 355 X h 394 mm
 Int. dim.: L 21.9 X w 14.0 X h 15.5"
 Wt: 3.66 kg/8.7 lbs., Colour: **grey**.
 SKU quantity: 25

**17 75 litres - Ref. 20086**

solid base, ventilated sides
 Ext. dim.: L 600 X w 400 X h 412 mm
 Ext. dim.: L 23.6 X w 15.8 X h 16.2"
 Int. dim.: L 555 X w 355 X h 394 mm
 Int. dim.: L 21.9 X w 14.0 X h 15.5"
 Wt: 3.08 kg/6.8 lbs., Colour: grey.
 SKU quantity: 25

75 litres - Ref. 20083

minimum order item
 as container ref. 20085
 with closed hand holds

Containers with reinforced bases

- Ribbed bases for heavy duty applications in automatic storage and for stacking.
- Arrangement of reinforcing promotes continuous movement on conveyors.

**1 21 litres - Ref. 2RP21**

minimum order item
 with reinforced base
 Ext. dim.: L 600 X w 400 X h 126 mm
 Ext. dim.: L 23.6 X w 15.8 X h 5.0"
 Int. dim.: L 555 X w 355 X h 115 mm
 Int. dim.: L 21.9 X w 14.0 X h 4.5"
 Wt: 1.69 kg/3.7 lbs., Colour: grey.

**2 33 litres - Ref. 20033**

minimum order item
 with reinforced base
 Ext. dim.: L 600 X w 400 X h 185 mm
 Ext. dim.: L 23.6 X w 15.8 X h 7.3"
 Int. dim.: L 554 X w 355 X h 162 mm
 Int. dim.: L 21.8 X w 14.0 X h 6.4"
 Wt: 2.57 kg/5.7 lbs., Colour: grey.

**3 45 litres - Ref. 20045**

minimum order item
 with reinforced ventilated base
 Ext. dim.: L 600 X w 400 X h 235 mm
 Ext. dim.: L 23.6 X w 15.8 X h 9.3"
 Int. dim.: L 555 X w 355 X h 211 mm
 Int. dim.: L 21.9 X w 14.0 X h 8.3"
 Wt: 3.0 kg/6.6 lbs., Colour: grey.

**4 75 litres - Ref. 20084**

minimum order item
 with reinforced ventilated base
 Ext. dim.: L 600 X w 400 X h 412 mm
 Ext. dim.: L 23.6 X w 15.8 X h 16.2"
 Int. dim.: L 555 X w 355 X h 385 mm
 Int. dim.: L 21.9 X w 14.0 X h 15.2"
 Wt: 4.6 kg/10.1 lbs., Colour: grey.